

## SPECIFICATION FOR APPROVAL LED HIGH POWER STREET LIGHT 40W



### Introduction

Rugged die-cast aluminum housing with corrosion resistant hardware, super durable powder coating finish withstand extreme climate changes without cracking or peeling.

Air-flow through heat sink design provides perfect heat management, lighter but stronger construction. Smooth and glossy processing with natural clean system prevents debris build-up and minimizes wind loading.

Modular design optimizes construction and assembly, allows for easy maintenance,

Tool-less access to the down-opening driver door makes easy maintenance and operation.

Dual-hoop mounting system fitted to 40-60mm (O.D.) mast-arms accommodates safety and stability.

IP66 rated to the luminaire

### Technical Data

<b>Model</b>	<b>LM-002-STM6CW-40W</b>
<b>Power</b>	40W
<b>Color Temperature Range</b>	2700-7000K
<b>Light Source</b>	Lumi LED / Bridgelux
<b>Power Supply</b>	Lyte Master (Dimmable) 1-10V / Equivalent
<b>Input Voltage</b>	AC 90-295V
<b>Luminous Flux</b>	6400 lm
<b>Luminous Efficiency</b>	160 lm/w
<b>Driver Efficiency</b>	>0.9
<b>Power Factor</b>	>0.95
<b>CRI</b>	Ra≥80
<b>Beam Angle</b>	60°/85°/110°/135°/140°
<b>Working Temperature</b>	-30°C~+55°C
<b>Light Body Color</b>	Silvery, Grey
<b>Net. Wt.</b>	<4.5 KG
<b>Life Span of LED</b>	>50,000 Hours
<b>IP Grade</b>	IP66
<b>Mechanical Protection</b>	IK10

### Optical & Photometric Diagram

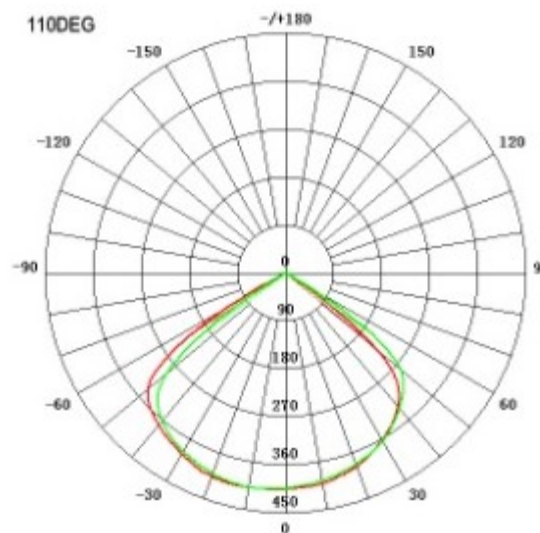

<b>Angle Adjustable</b>	Yes
<b>Overheating Protection</b>	Yes
<b>Over-voltage Protection 10KW</b>	

## Illuminance Diagram

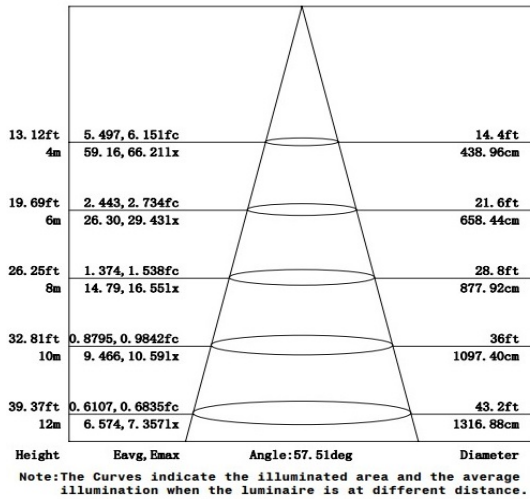

## Lumiance Intensity Distribution

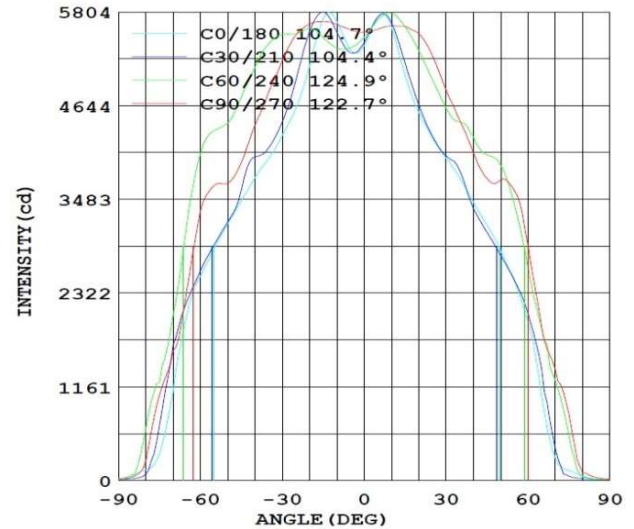

### LED & Optics –

Eutectic led packaging technology is applied for low heat resistance, low light degradation, high efficiency and long life (Projected L70>100000h @ Ta 25C). High efficiency Pure white (5000-5800K) & Warm white (4000-4500K) with CRI 80 rated or customized CCT LED are available. Light efficiency is up to 155lm/W

Precise optic lens in high intensity PC material with IESNA Type I, Type II & Type III provides high uniformity and optimal luminaire spacing, the optical system optimizes the light distribution, eliminate the waste of light, increase the reasonable and effective using of light.

### Electronics –

Universal driver is available in 100-240Vac, 50/60Hz, power factor > 95% and THD <15%, IP67 waterproof.

Tool-less 360 degree rotatable twist-lock photocell control ANSI C136.10 compliant is available for options.

0-10V or PWM dimming is available for options, control by others.

## Features

1. Using high-power LED, long life
2. Optical decline of small, green, low maintenance costs
3. Easy installation, excellent thermal design guide
4. Protection performance, meet the anti-poor environments
5. Sunflower aluminum lamp body, excellent heat dissipation
6. Reduce the entire lamp operating temperature, extended life light sources

## Dimension

Product Size 444\*307\*139mm

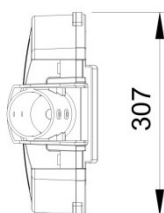
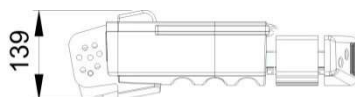

## Packaging

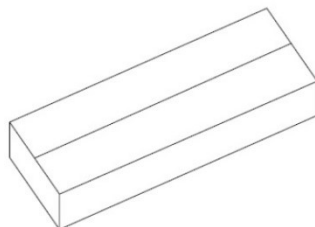
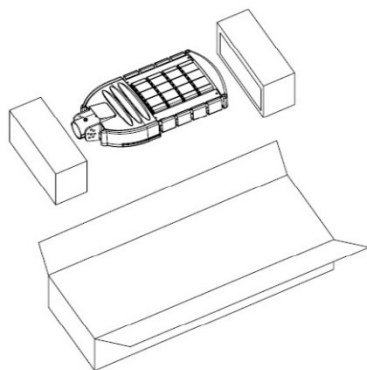

Packing dimension  
490\*355\*185

Net Weight  
<4.5 Kg

## Certificates & Standards

Type of Protection	IP66
Mechanical Protection	IK10
Standards	CE, RoHS

## Installation

1. Open the driver box, loosen PG9 connector, get the driver wire through the PG-9 connector, tighten the connector and close the driver box.

Open the driver box

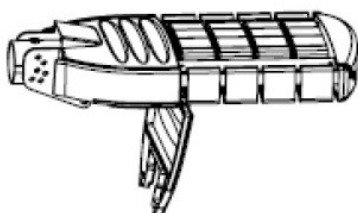

Tighten the screws

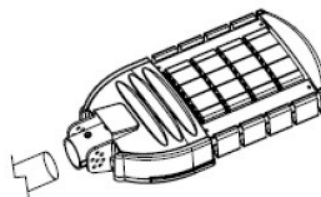

2. Adjust the led street lights to a suitable position according to your requirements for lighting. Then tight the screws. The mounting bracket is adjustable each 5 deg from  $-15$  deg to  $15$  deg , 90 deg for straight pole is available.

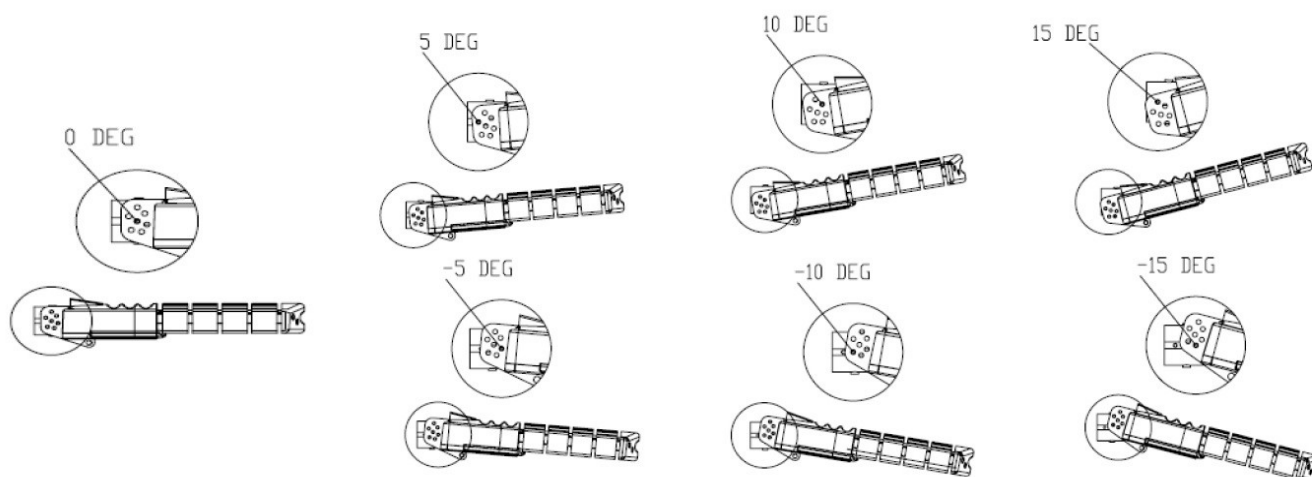

## Install Caution

1. Installation should be done by professional electricians;
2. Please make sure all power is turned off before installation completed.
3. Please ensure the power supply wire grounding is normal.
4. Please ensure the hook tighten well;
5. When connecting wires, don't make any frictions or drop off the product, otherwise will cause damage.
6. Be sure to install the lights correctly, the power cord bare wire must be connected with insulation protection.
7. When connecting wires, should clearly know Neutral wire, Earth wire and Live wire to assure safety.

After examination, switch on

## Power Supply Connection

### Power Supply Connect Caution

1. If the Power cord of this luminaries is damaged, it shall be exclusively replaced by the manufacturer or his service agent or a similar qualified person in order to avoid a hazard.
2. Non –user replacement light source: "The light source contained in this luminaries shall only be replaced by the manufacturer or his service agent or a similar qualified person."



Caution, risk of electric shock

3. A wiring device shall be provided for connection to a branch circuit. The wiring device shall be rated for the temperatures, locations, voltage, and current encountered during normal operation.

For Example

- 3 PIN Screw less terminals
- Rated voltage 250V
- Rated connecting capacity 1.5-2.5mm<sup>2</sup>
- Conductors be tinned
- If necessary please provide the wiring compartment placed the terminal block

## Trouble removal & Maintenance

### Trouble removal (Nonprofessionals should not disassemble the lamp.)

Fault finding and solutions: When examination, observe any change in colour circumstances at LED source appearance or damage, any obvious breakage of connections, loose power supply connections, any short circuit, any obvious damage condition please replace with new LED source or driver.

Defect	Possible factors	Solutions
LED source not bright	Wrong connecting wires	Loose the screws, re-connecting the wires
	LED source damage	Replace LED source
	Power failure	Replace LED driver
LED source flicker	Virtual power supply connecting	Loose the screws, re-connecting the wires
	Input voltage fluctuation	Confirm input voltage
	Power failure	Replace LED driver

### Maintenance

1. Please make sure all power turned off before maintenance.
2. Clean the shade surface periodically, to keep good reflectivity.

3. Clean the lamp heat sink periodically, to keep good heat dissipation.
4. Clean with dry cloth, don't use water or corrosive liquid.
5. When replace driver, connect the wires as follows: AC Power supply three core wires, connect power input: brown line connect with the "L", blue line connect with the "N" , yellow-green or yellow line connected into the lamp body of insulation. Light source lead to connect power output: the red connection with the light source is the positive (red line), the black thread and the light source cathode (black line), positive and negative must not be connected wrong.

## Warranty clause

- **Product warranty**

Lyte Master GmbH warranty the products within 5 years from delivering to customers, we will be responsible for repair and replacement, if any conditions such as not bright or flicker of LED source under right preservation, installation, usage and maintenance.

- **Disclaimer and limitation**

1. Under any circumstances, any quality problems compensation should be within the warranty period.
2. The product warranty does not include: Product damage caused by.
  - 2.1 The negligence of storage, transportation or improper handling.
  - 2.2 Incorrect operation or not proper usage of product.
  - 2.3 Any damage caused by repair or modifications from unauthorized person.
  - 2.4 Caused by the forces of nature, irresistible factors of product damage, such as Earthquakes, typhoons, tornadoes, volcanic eruptions, floods, lightning, heavy snow, war, etc.
3. If the product serial number has been changed, altered or blur, it will no longer enjoy the corresponding Warranty.
4. This warranty is not responsible for repair or replacement of the transport, customs clearance fee.

## Application

General lighting for all roadways, avenues, street etc., area and site lighting for parking lot, playground, sport area etc. Available to replace traditional HID luminaires up to 500W.



### Notes

Non-professionals are not allowed to disassemble and maintain the products. We have the right not to provide after-sale service if unauthorized disassembly and maintenance happens to the products.